

SMD TYPE CERAMIC (SMD 4 x 2.5)

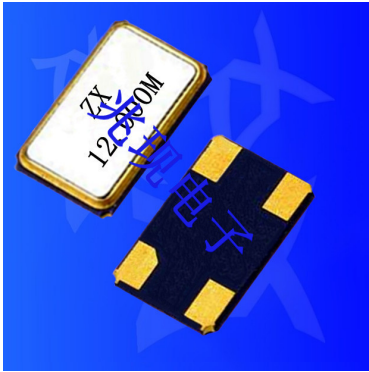

Application of SMD crystal

- Radio communication
- CRYSTAL
- Office automation equipment
- GPS
- Audio-visual equipment

{Features}

Seam welding
 Excellent solderability
 Automatic and perfect packing due to emboss taping
 Excellent vibration resistance & shock resistance
 Rohs compliant / Pb free



Electrical Specification:

Model	\ Z -4025mm
1.Frequency	
Frequency Range	10.1 ~ 40.0 MHz
Frequency Tolerance at 25 ℃ ±2 ℃	±10 ~ ±30 ppm (TYP.)
Frequency Stability Over Operating Temp Range	±10 ~ ±30 ppm (TYP.)
2.Environmental Condition	
Operating Temp Range	-10 ℃~ +60 ℃, -20 ℃~ +70 ℃ or customer requirement
Storage Temp Range	-40 ℃ ~ +85 ℃
Aging Rate	±3ppm/year
3.Electrical Specifications	
Test Circuit	S&A 250B
Load Capacitance	6 pF ~ 32 pF, series or special
Drive Level	1uW ~ 100uW or special
Shunt Capacitance	7.0pF max

Equivalent Series Resistance(ESR) VS Frequency:

Frequency (MHz)	Oscillation Mode	\ Z-42
10.1 ~ 22.0	Fundamental	80
22.1 ~ 40.0	Fundamental	60

Dimensions (mm):

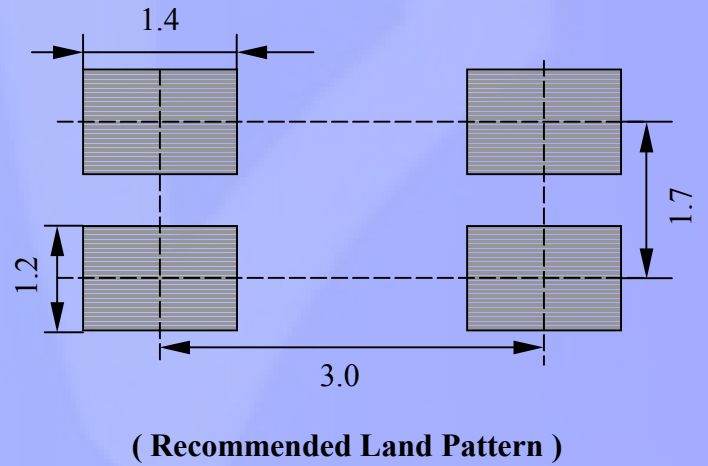
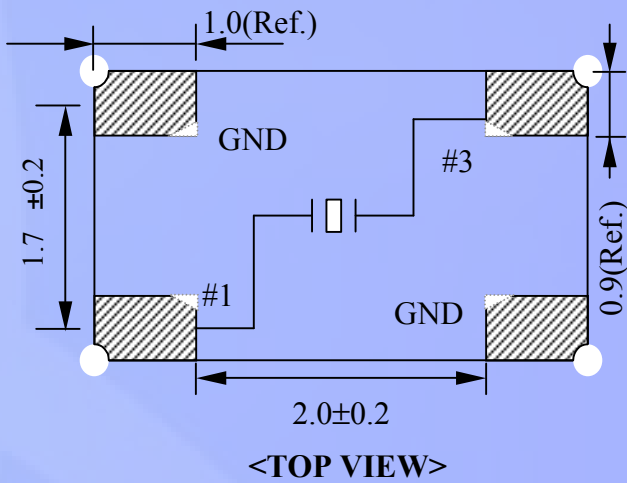
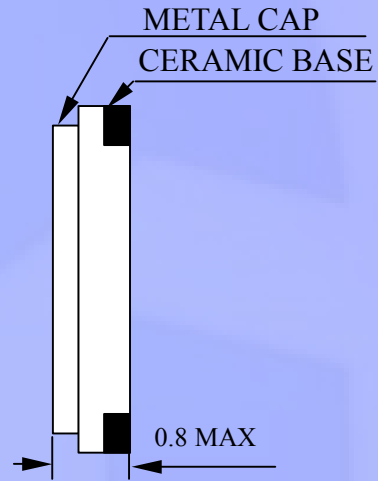
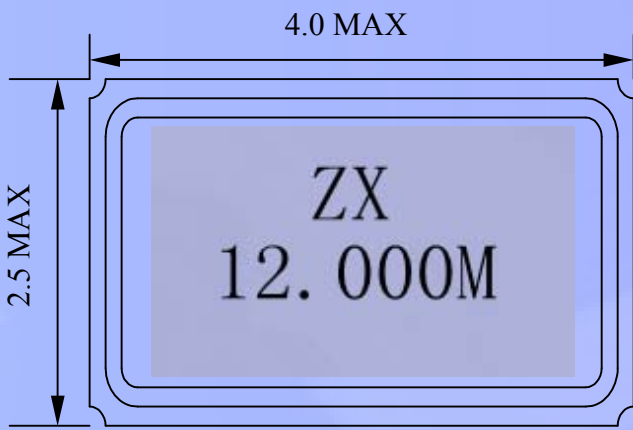

Tape specification (mm):

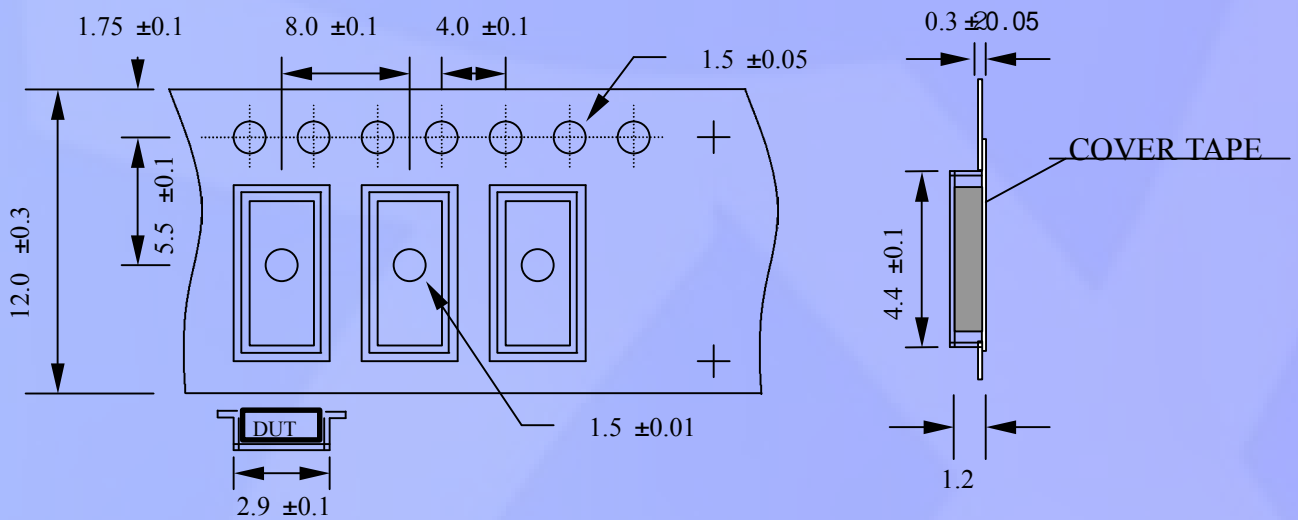

Reel packing (mm):

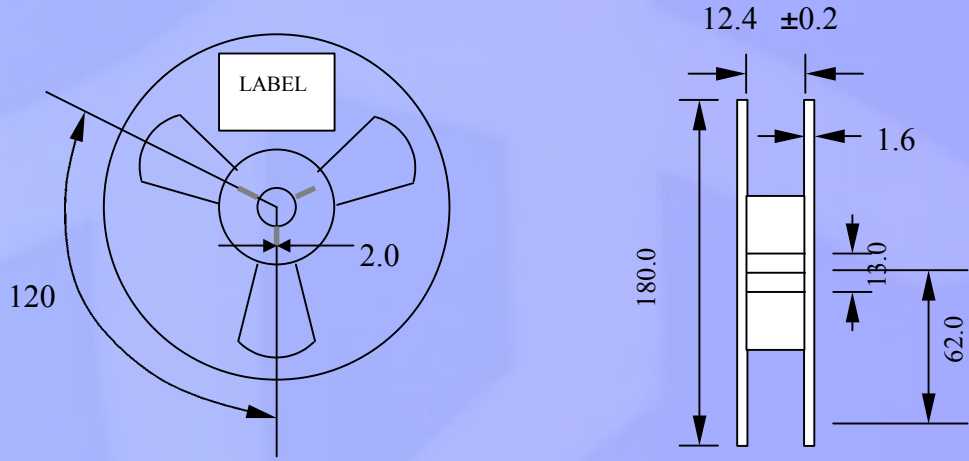

Reflow Temperature profile:

